

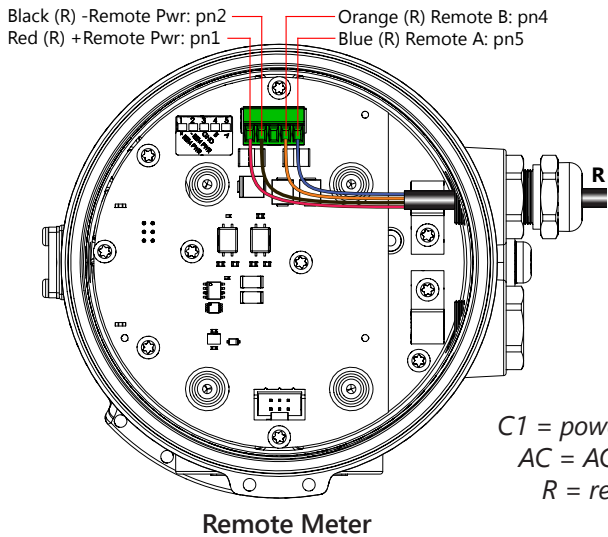

Wiring

Remote Meter: Unscrew the user access lid and remove it. Remove the 5 pin screw connector from its socket. Install the wires through the cable port into the 5 pin screw connector in their respective locations. Plug the 5 pin screw connector into its socket. Refer to the complete manual for further details.



Remote Display: Remove the 3 screws holding the display assembly and remove it from the meter. Remove the 15 pin screw connector from its bag. Install the wires through the cable ports into the 15 pin screw connector in their respective locations. Plug the 15 pin screw connector into its socket. **Be sure all pins align properly and that the connector has not slipped to one side.** Refer to the complete manual for further details.

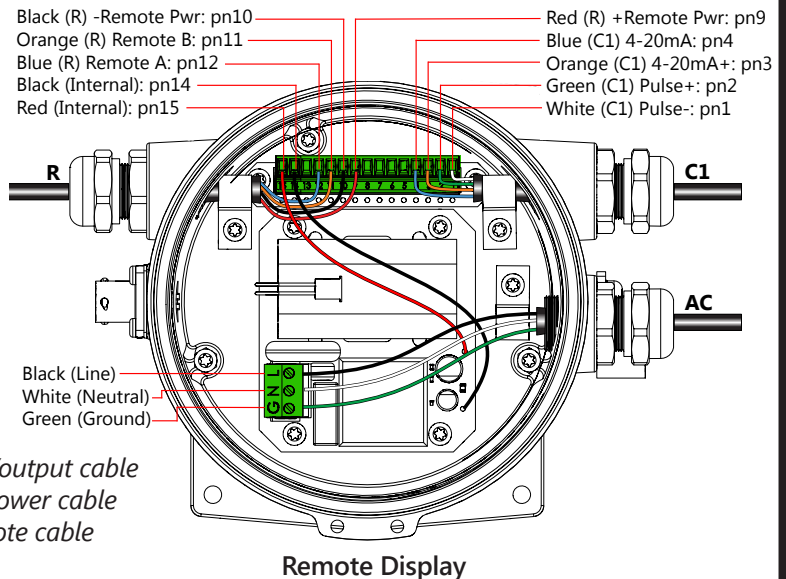

C1 = power/output cable
AC = AC power cable
R = remote cable

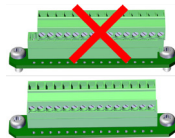
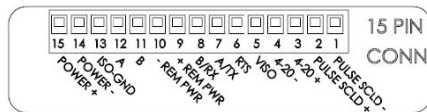

Be sure all pins align properly and that the connector has not slipped to one side.

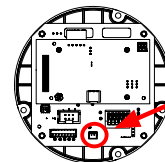

Plug the backup battery cable into the back of the display assembly.

WARNING: BACKUP BATTERIES ARE NOT INTENDED AS A PRIMARY POWER SOURCE



WARNING: Improper sealing of glands or cables will invalidate any warranty. If plugs or cable glands are removed, reinstall using Teflon pipe sealant, or tape, to ensure maximum moisture protection.



Remove plug & o-ring. Insert cable gland/strain relief. Feed cable through cable gland.

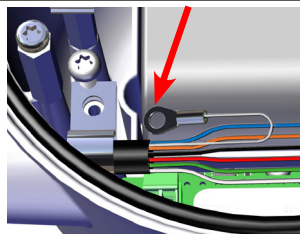

Clamp cable with strain relief clips. Attach drain wire lug to bracket post.

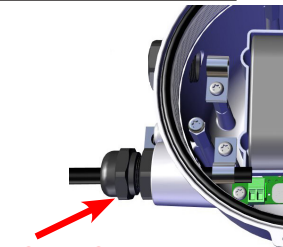

CRITICAL!
Torque cable gland sealing nut to 22 in-lbs.

Refer to the **Mechanical Quick Start Guide** or the complete instruction manual for details on mechanical installation.

Menu System



The **HOME Screen** displays flow volume, direction of the flow total and flow RATE along with status conditions such as Empty Pipe. Two buttons below the LCD display are used to access menu screens for viewing and changing meter setup parameters.

These two buttons are light sensors which can detect when a finger is covering them. Only three button touch actions are needed to control navigation through the menus, settings changes and back to the home screen.



HORIZONTAL SCROLLING:

Tap right-hand button to scroll horizontally through menu tabs or move horizontally within a tab dialog when applicable.



SELECT: Tap left-hand button to change a highlighted item within a tab dialog.



ENTER/EXIT: Hold left button while tapping right button once to enter or exit a tab dialog or to navigate between the HOME and other menu screens.

All menu screens consist of two rows of tabs surrounding a dialog box that lets you view and change setup parameters. To enter the Menu System perform the hold and tap sequence.



Changing Settings

T UNIT

View or change TOTAL volume units

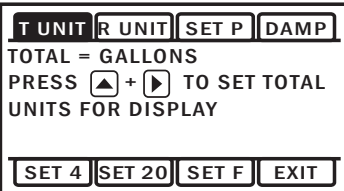

SET 4

View or change flow rate corresponding to 4mA

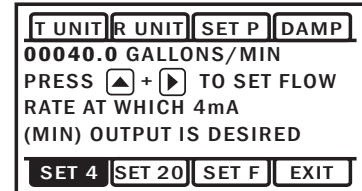

R UNIT

View or change flow RATE units

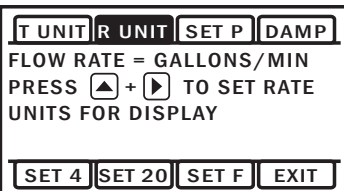

SET 20

View or change flow rate corresponding to 20mA

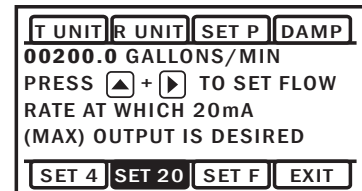

Set P

View or change pulse output scaling

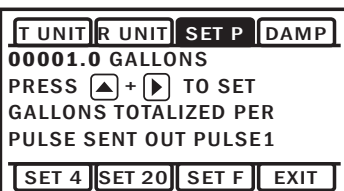

EXIT

Return to HOME SCREEN or enter SUBMENU

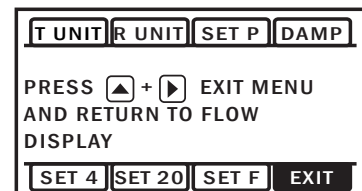

DAMP

View or change # of samples for rolling average.

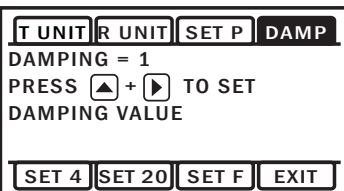

The **EXIT** tab in the MAIN MENU has a second function. If you tap five times, you will be redirected to a SUBMENU screen from which you can access additional options.

INFO: Meter model, serial number, firmware version
HPOLL: HART address