

General Information

The FT522 is a flowmeter monitor with added output and alarm features. It is designed for use with SeaMetrics flow meters and sensors, as well as other units which have a pulse or frequency output. It displays flow rate and total in large digits on an easily-read backlit display. Units are user selectable between gallons, cubic feet, and cubic meters.

The primary output of this unit is a user-set alarm relay which signals excess total flow within a given time period (up to 48 hours). This is typically used to detect an overly high usage level in a cooling tower or potable water application. The dual relays can be connected to an alarm, autodialer, or any other switch-controllable device.

In addition to the usage alarm, the FT522 has analog output (4-20 mA, 0-10 VDC) and programmable pulse output. These can be used for data logging or to provide proportional chemical feed, using an externally-controlled metering pump.

Specifications

Power	115/220 VAC, 50/60 Hz, 12-24 VDC
Temperature Enclosure	32° - 130° F (0° - 55° C) Precision cast aluminum, NEMA 4X
Alarm Outputs	Two Form C SPDT relay, 115 VAC 5A max
Max Pulse Output	100 mA at 60 VDC
Memory Type	Non-volatile EEPROM auto-backup
Sensor Power	12 VDC, 10 mA
Totalizer	8 digit
Rate Display	5 digit
Volume Units	Gallons, cubic feet, cubic meters
Time Units	Minutes, hours
Analog Output	4-20 mA, 0-10 VDC, opto-isolated
Sensor Input	Open collector current sink, ESD protected
Max Input Frequency	1,000 Hz
Shipping Weight	7 lbs

Features

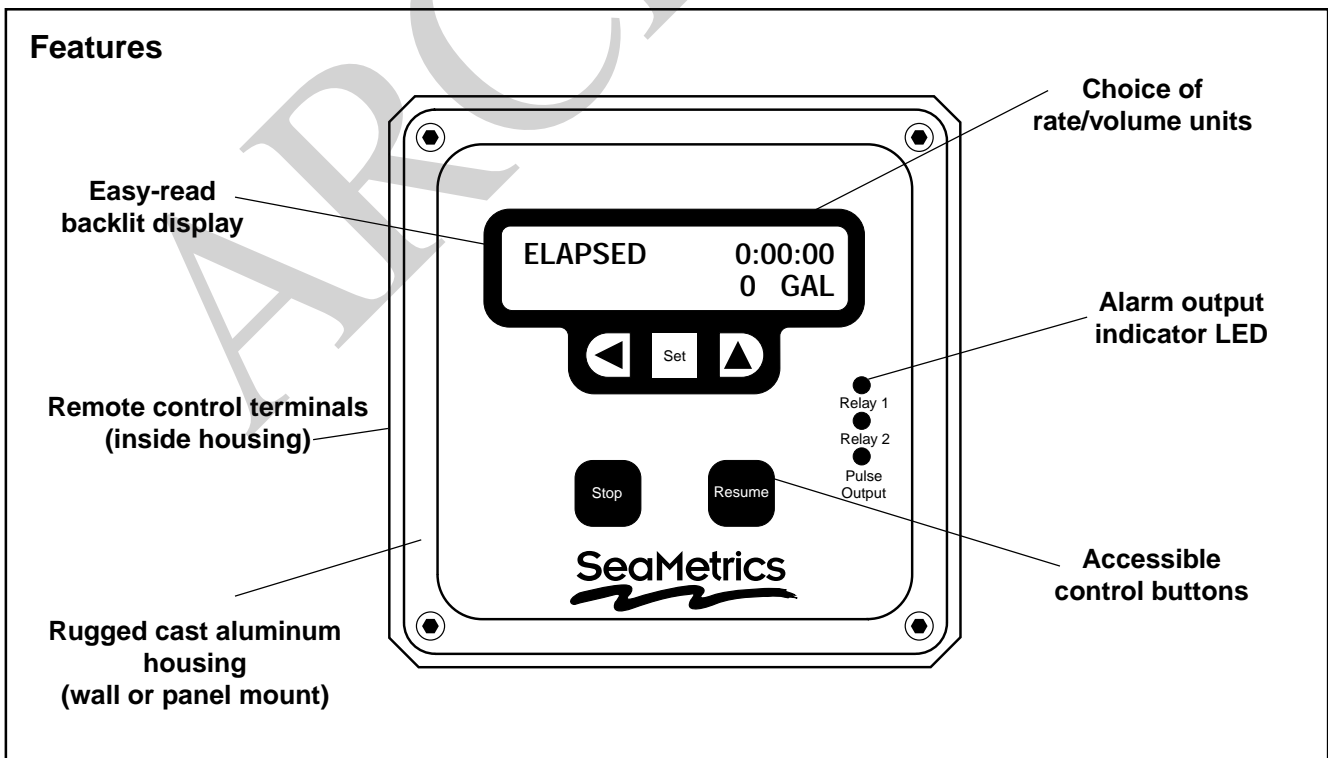

Installation

Wall Mounting. Using the eight screws provided, attach the two foot brackets to the sides of the enclosure. Then attach the unit to any secure surface by inserting screws through the mounting holes in the foot brackets.

Panel Mounting. Follow the dimensions given for “Panel Cutout”. Be sure to include the four corner screw holes. After cutting and drilling, place the front plate on the front side of the panel with its gasket against the panel, and the remainder of the square housing on the back side. Slide the screws through the four holes drilled in the panel, and into the threaded holes in the housing. Tighten until the gasket is firmly compressed against the panel.

Expose Terminals. Remove the four screws which hold the front plate to its flange. Remove the front plate. The display board is attached to this front plate. It is also connected to the power board by a ribbon cable. For convenience, this cable can be disconnected, or the display board can be allowed to dangle while making connections. Connections can be made inside the enclosure, or the terminals can be unplugged for easier access, by gently tugging on them.

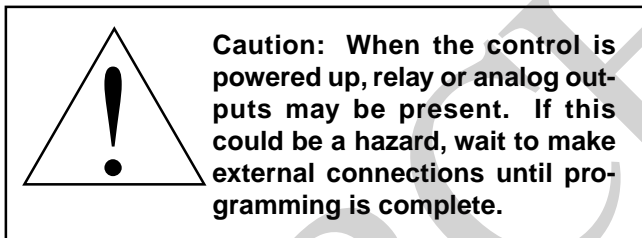

Sensor Connection. Follow the “Connections” diagram to connect either two or three wires from the flow meter or flow sensor.

Monitor Alarm Connection. Connect the alarm devices to the appropriate relay terminals. Note that the relays have both normally-open (NO) and normally-closed (NC) contacts.

Power Connection. Connect AC or DC power as desired to the appropriate terminals. For safety, if using AC power, be sure to connect the ground terminal provided to a good earth ground.

Replace the front panel, taking care to reconnect the ribbon cable if it has been disconnected. When power is switched on, the display should light up immediately with meaningful letters or digits.

Displays

OPERATION MODE

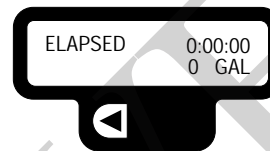
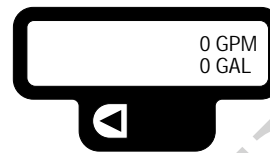





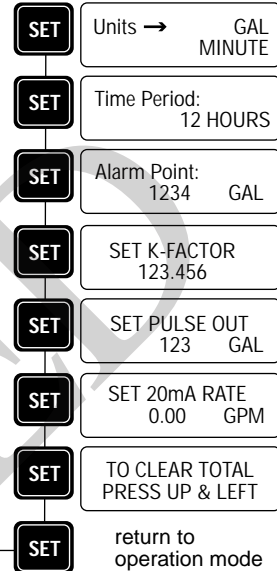

Flow Monitor

SETTINGS



Settings

Set Units. Use  to select volume units. Use  to select the particular unit desired (gallons, liters, etc.). Then use  to switch to time units. Again, select the one desired.

Set Time Period. This is the monitoring period at the end of which the unit will alarm if total flow has exceeded its setting. To set this monitoring period in hours, use the  and  keys. The digit which is underlined is the one being set. Use the  to increase it. The  moves one digit to the left. Note that if the digit to the right is set to “9”, the digit to the left will only go to “3”. This is because 48 is the maximum setting allowed.



Set Alarm Point. This is the maximum total flow allowed in the time period set above. Use the same procedure as above to set this value, up to nine digits. The units are as shown (previously chosen).

Set K-Factor. The unit will not function properly until this number is entered. It is simply the number of pulses which the flow meter or flow sensor puts out per gallon of liquid. It is marked on the Model/Serial tag of SeaMetrics flow meters and flow sensor fittings. On

adjustable flow sensors, the K-factor must be taken from the chart in the flow sensor instructions, based on pipe size. Set using the same procedure as above.

Set Pulse Out. An output pulse is activated at the selected volume intervals if this feature is in use. Otherwise, it does not need to be set.

Set 20 mA Out. A 4-20 mA analog output is standard on this unit. If a 4-20 mA current loop is connected, set the flow rate, in the desired units, at which the peak 20 mA is desired. The controller will automatically scale the 4-20 mA output to zero flow.

Clear Total. This function resets the running total (not alarm point total) back to zero. It does not affect the alarm point total, which automatically resets itself at the end of every monitoring time period. To reset to zero, press  and  simultaneously, as instructed.

Operation

The last press of the **SET** key returns the unit to operation mode (see "Displays" diagram). In this mode, pressing either arrow key will toggle back and forth between two displays, one for flow monitoring and the other for usage monitoring.

Usage Alarm. Pressing the Start/Stop key will start the clock and zero the total of the usage monitor. The clock will increase and the total will accumulate (provided there is flow) until the end of the monitoring period. At that time, the usage total and clock will zero automatically and the cycle will start over. If the usage total ever reaches its alarm point within the monitoring time, the usage alarm relays will energize and remain on until the Resume key is pressed.

If the Resume key is pressed during a monitoring cycle, it will freeze the cycle at its current point. Pressing it again allows the cycle to resume where it left off.

Flow Monitoring. The "Rate" indication gives the current rate of flow. "Total" is a running total of flow which increases indefinitely unless it is reset (see procedure under "Settings".)

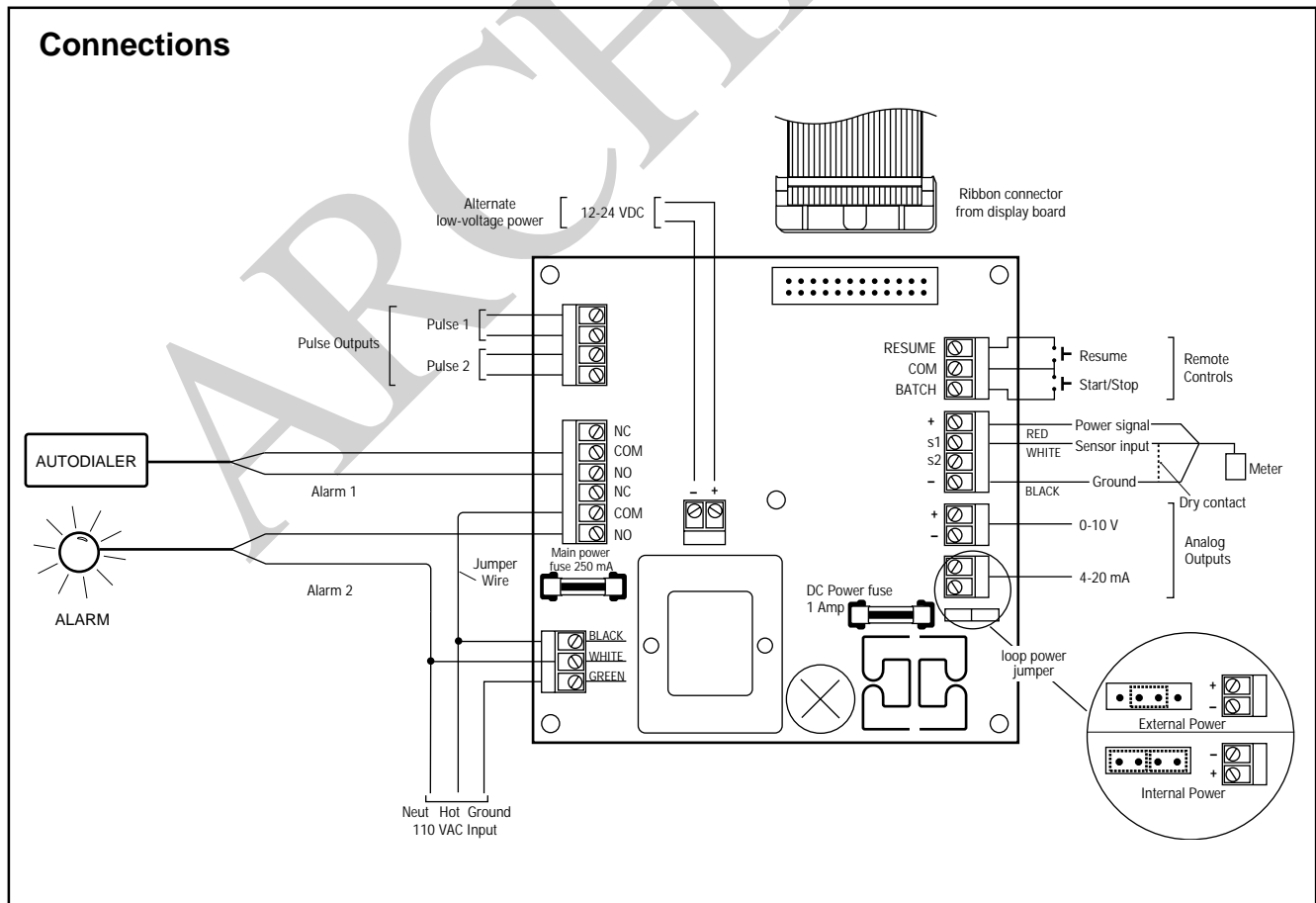

Repair

The only field-repairable component on the FT520 is the fuse. If failure is due to a cause other than a blown fuse, it is necessary to replace the entire board stack. Contact your distributor for information.

Fuses. The power supply and the analog output circuit have fuse protection. The two fuses are on the board. Replace the blown power fuse with a 250 mA, 5x20 mm glass fuse, available from SeaMetrics or from Radio Shack (or other electronic supply store). The DC power fuse is a 1 Amp, 5x20 mm glass fuse.



Caution: Always disconnect power to the unit before opening the terminal cover. Do not reconnect power until all connections have been made and the terminal cover has been replaced.

Panel cut-out dimensions

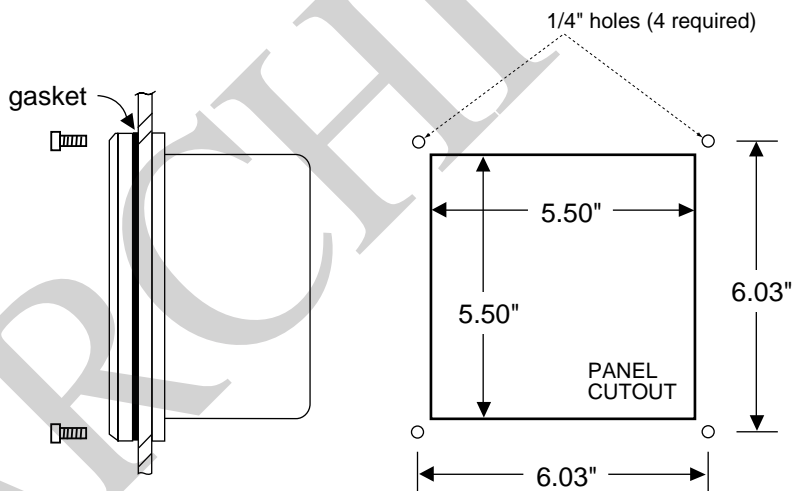

SeaMetrics

20419 80th Ave. So., Kent WA. 98032 USA
Phone: 253-872-0284 Fax: 253-872-0285
www.seametrics.com 1-800-975-8153